

T-41-73

GP2S05/GP2S15

Subminiature Photointerrupter with Lens

■ Features

1. Focal distance : 4mm
2. Easy to install into cartridge due to the snap-in type package
3. Visible light cut-off type
4. Long lead pin : 12.5mm (GP2S15)

■ Applications

1. Copiers, printers, facsimiles
2. Cassette decks, video decks
3. Record players

■ Outline Dimensions (Unit : mm)

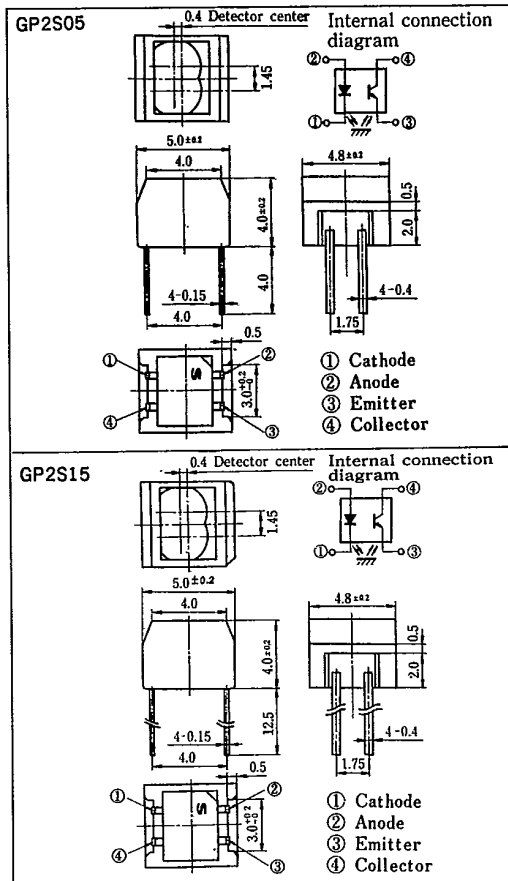

■ Absolute Maximum Ratings

(Ta=25°C)

	Parameter	Symbol	Rating	Unit
Input	Forward current	I_F	50	mA
	Reverse voltage	V_R	6	V
	Power dissipation	P	75	mW
Output	Collector-emitter voltage	V_{CEO}	35	V
	Emitter-collector voltage	V_{ECO}	6	V
	Collector current	I_C	20	mA
	Collector power dissipation	P_C	75	mW
	Total power dissipation	P_{tot}	100	mW
	Operating temperature	T_{opr}	-25 ~ +75	°C
	Storage temperature	T_{stg}	-40 ~ +80	°C
	*1 Soldering temperature	T_{sol}	260	°C

*1 For 5 seconds at the position of 1mm from the bottom face of resin package

SHARP

T-41-73

Electro-optical Characteristics

(Ta=25°C)

Parameter	Symbol	Conditions	MIN.	TYP.	MAX.	Unit	
Input	Forward voltage	$I_F=20\text{mA}$	—	1.2	1.4	V	
	Reverse current	$V_R=3\text{V}$	—	—	10	μA	
Output	Collector dark current	$V_{CE}=20\text{V}$	—	10^{-9}	10^{-7}	A	
Transfer characteristics	*2 Collector current	$V_{CE}=5\text{V}$, $I_F=20\text{mA}$	GP 2S05	1.4	—	12	%
			GP 2S15	0.5	—	12	%
	Response time (Rise)	t_r	$I_C=100\mu\text{A}$, $V_{CE}=2\text{V}$	—	20	100	μs
	Response time (Fall)	t_f	$R_L=1\text{k}\Omega$, $d=4\text{mm}$	—	20	100	μs
*3 Leak current	I_{LEAK}	$I_F=20\text{mA}$, $V_{CE}=5\text{V}$	—	8	40	μA	

*2 The condition and arrangement of the reflective object are shown below.
 *3 Without reflective object

Test Condition and Arrangement for Collector Current

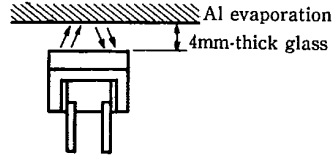

Fig. 1 Forward Current vs. Ambient Temperature

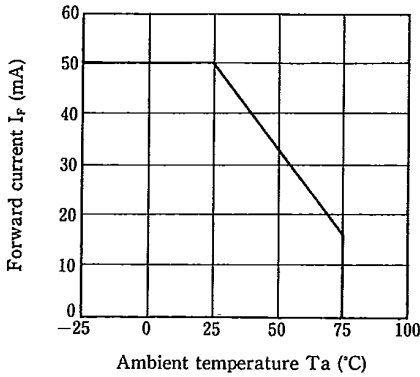

Fig. 2 Power Dissipation vs. Ambient Temperature

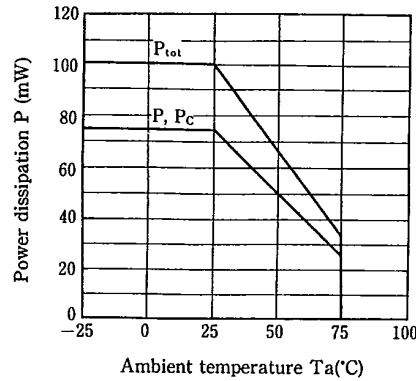

Fig. 3 Peak Forward Current vs. Duty Ratio

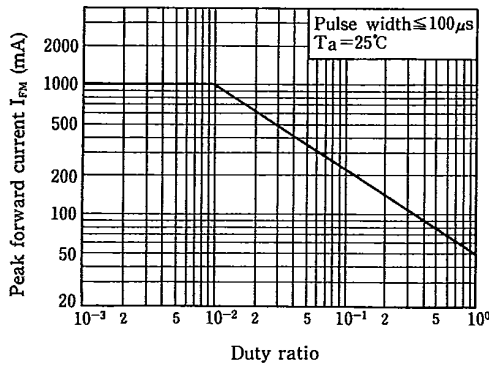

Fig. 4 Forward Current vs. Forward Voltage

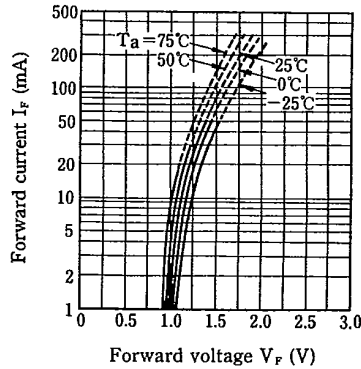

Fig. 5 Collector Current vs. Forward Current

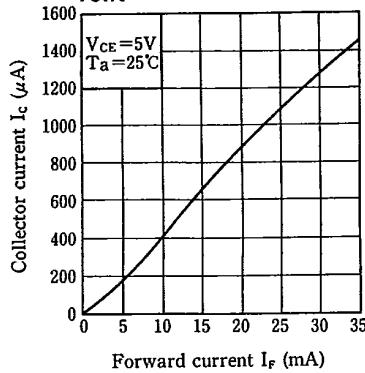

Fig. 6 Collector Current vs. Collector-emitter Voltage

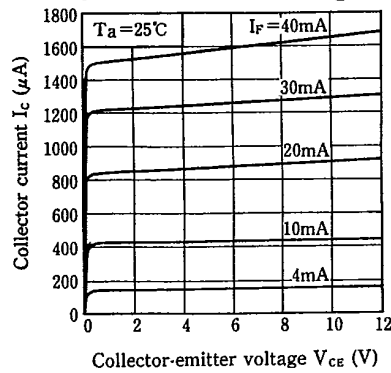

Fig. 7 Relative Collector Current vs. Ambient Temperature

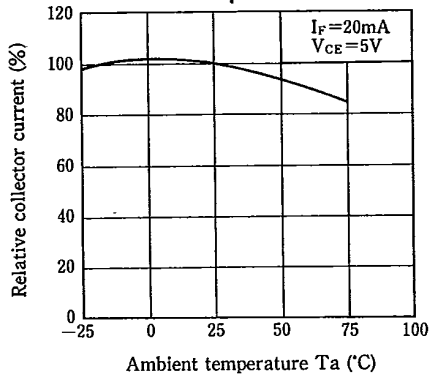

Fig. 8 Collector Dark Current vs. Ambient Temperature

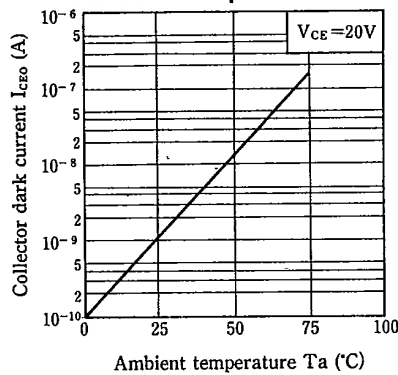
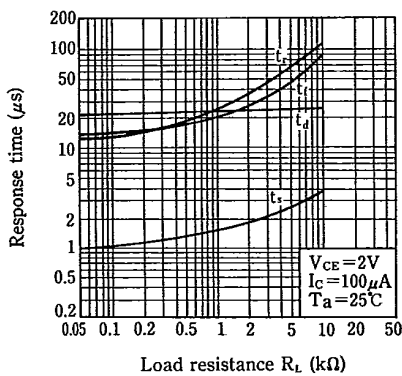
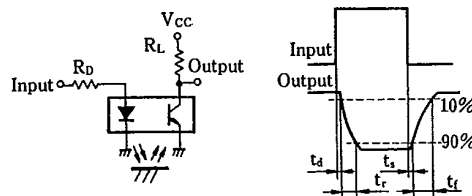

Fig. 9 Response Time vs. Load Resistance



Test Circuit for Response Time



T-41-73

Fig.10 Relative Collector Current vs. Distance between GP2S05 (GP2S15) and Evaporation Glass

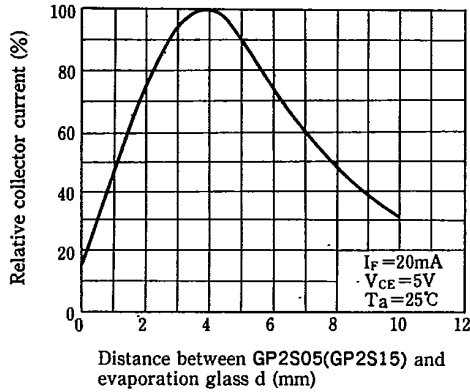

Fig. 11 Relative Collector Current vs. Card Moving Distance (1)

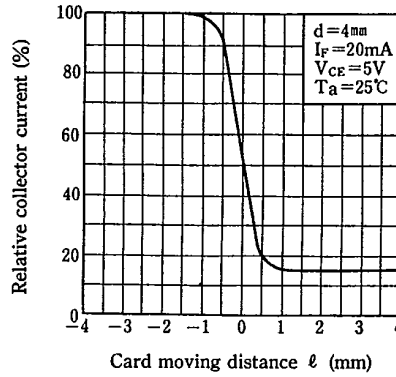
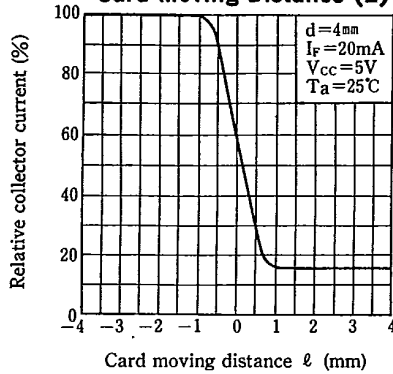

Fig. 12 Relative Collector Current vs. Card Moving Distance (2)



Distance Characteristic Test Condition

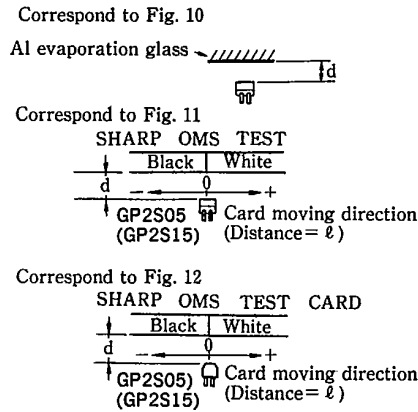

Fig. 13 Frequency Response

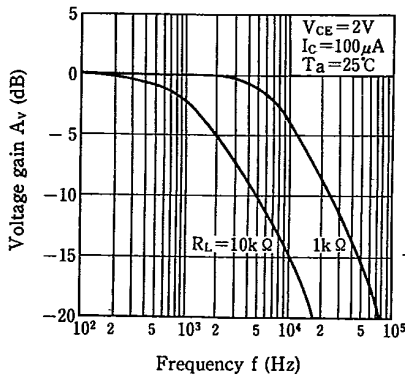

Fig. 14 Spectral Sensitivity (Detecting Side)

